

DAMHUS

115322/701-206-1020

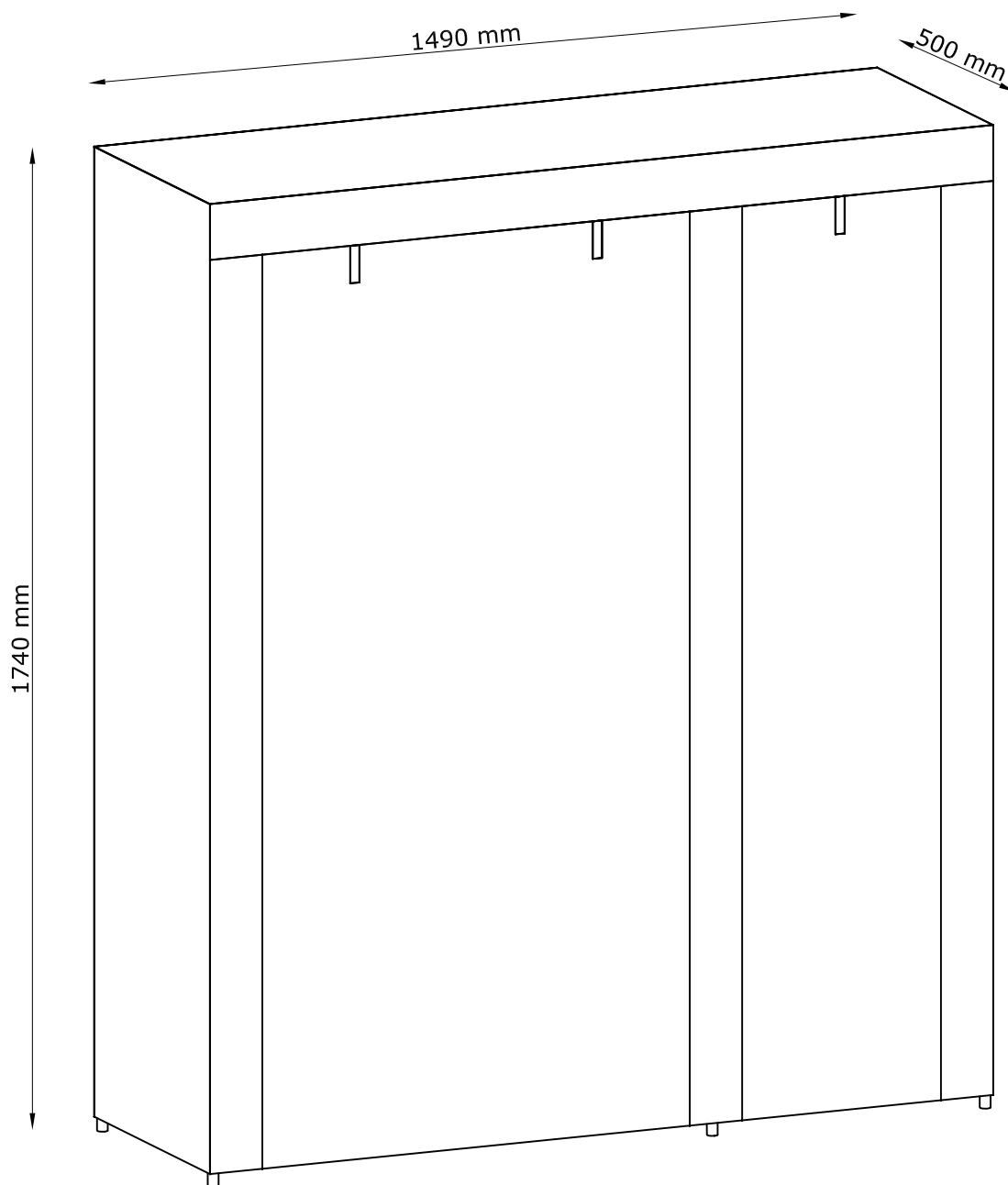

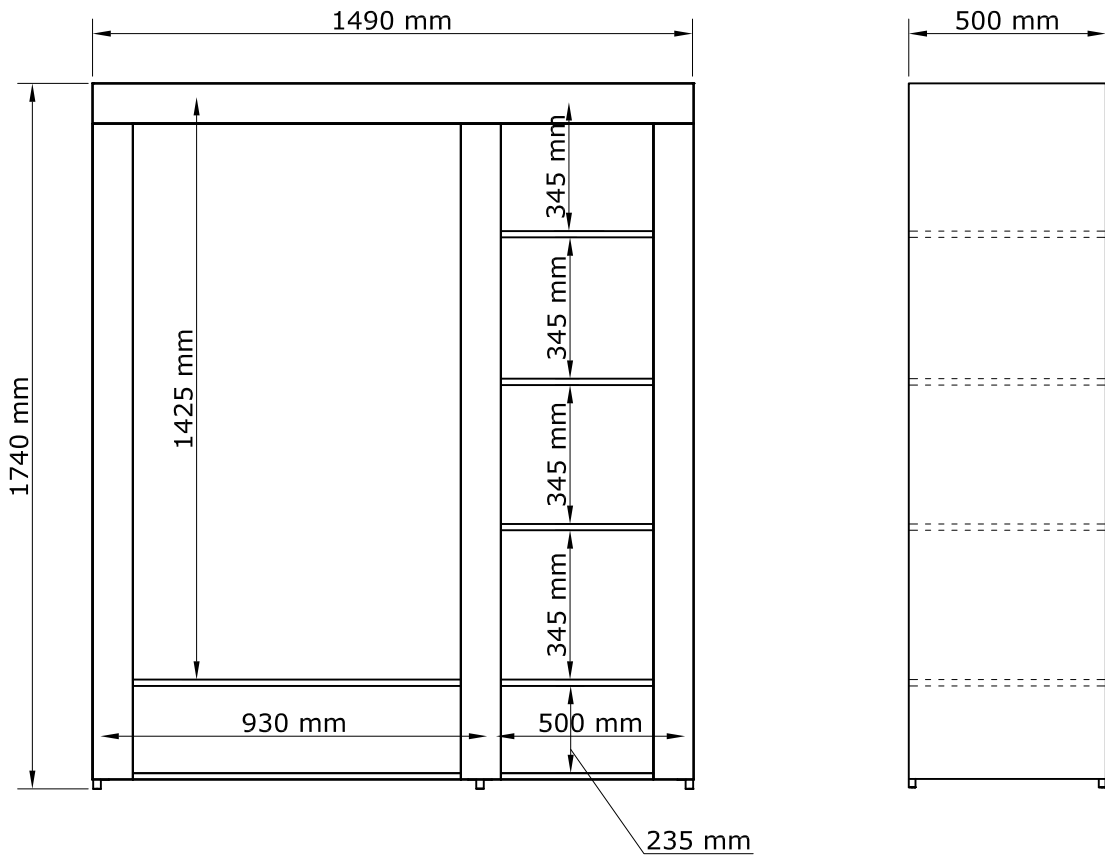

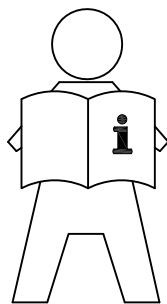

EN: IMPORTANT INFORMATION!

Please read the entire manual carefully before starting to assemble and/or using this product. Follow the manual thoroughly and keep it for further reference.

FR: INFORMATIONS IMPORTANTES

Veillez lire attentivement l'ensemble du manuel avant de commencer à monter et/ou utiliser ce produit. Suivez rigoureusement le manuel et conservez-le pour toute consultation ultérieure.

LV: SVARĪGA INFORMĀCIJA!

Pirms šī izstrādājuma montāžas un/vai lietošanas uzsākšanas pilnībā izlasiet lietošanas pamācību. Stingri ievērojiet pamācības norādījumus un saglabājiet to turpmākai lietošanai.

LT: SVARBI INFORMACIJA!

Prieš pradėdami montuoti gaminį ir (arba) juo naudotis, prašome atidžiai perskaityti visą vadovą. Atidžiai skaitykite vadovą ir turėkite jį su savimi, kad galėtumėte toliau vadovautis jo nuorodomis.

EE: OLULINE TEAVE!

Enne kui alustate toote kokku panemist ja/või kasutamist, lugege see kasutusjuhend hoolikalt läbi. Järgige täpselt juhendis toodud juhiseid ja hoidke juhend alles.

BY: ВАЖНАЯ ИНФОРМАЦИЯ!

Внимательно и полностью прочитайте это руководство, прежде чем приступать к сборке или использованию этого изделия. Следуйте всем инструкциям этого руководства и сохраните его на будущее для справки.

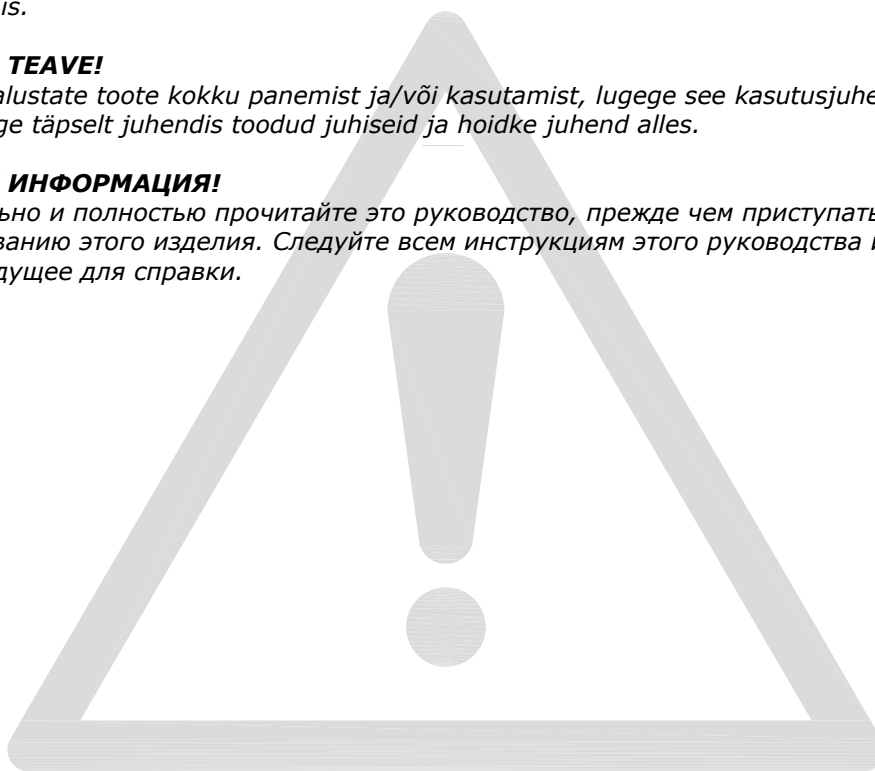

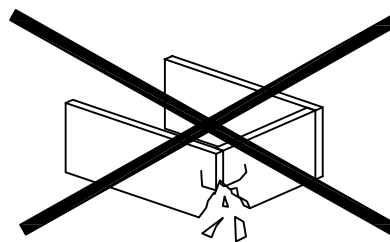
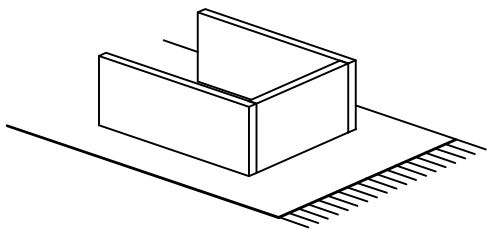

EN: WARNING TO AVOID SCRATCHES!

In order to avoid scratching this furniture should be assembled on a soft layer - could be a rug.

FR: AVERTISSEMENT POUR ÉVITER LES RAYURES

Afin d'éviter les rayures, ce meuble doit être monté sur une surface souple (un tapis, par exemple).

LV: BRĪDINĀJUMS PAR SKRĀPĒJUMIEM!

Lai nesaskrāpētu šo izstrādājumu, veiciet montāžu uz mīkstas pamatnes, piemēram, paklāja.

LT: ĮSPĖJIMAS, KAD IŠVENGTUMĖTE ĮBRĖŽIMŲ!

Šio baldo nesubraižysite, jei jį surinksite ant švelnaus paviršiaus, pavyzdžiui, kilimo.

EE: HOIATUS KRIIMUSTUSTE VÄLTIMISEKS!

Kriimustuste tekkimise vältimiseks mööblile tuleb see kokku panna pehmel pinnal, nt kaltsuvaibal.

BY: ПРЕДУПРЕЖДЕНИЕ ОТНОСИТЕЛЬНО ЦАРАПИН!

Во избежание нанесения царапин, сборку этой мебели необходимо выполнять на мягкой поверхности, например на ковре.



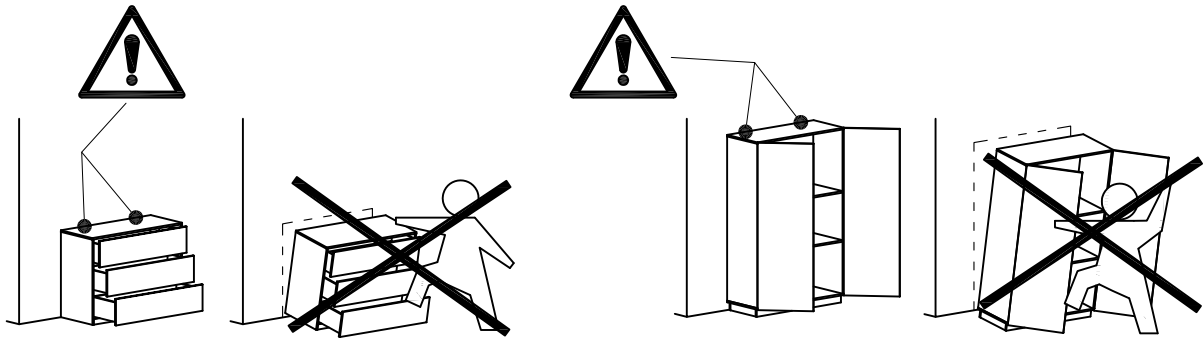

EN: ANTI-TOPPLE WARNING!

This product has to be permanently fixed to the wall with the bracket(s) included, to avoid fatal injury in case it topples over. The pack only contains screws for fastening the anti-topple bracket(s) itself to the product. Please contact your DIY or hardware store for advice on the correct type of screws/raw plugs for your type of wall.

FR: AVERTISSEMENT ANTIBASCULEMENT

Ce produit doit être fixé de manière permanente au mur à l'aide du/des support(s) inclus afin d'éviter des blessures mortelles en cas de basculement. L'emballage contient des vis pour attacher le(s) support(s) antibasculement au produit. Veuillez contacter votre magasin de bricolage ou votre quincaillerie pour obtenir des conseils sur le type de vis/chevilles adapté à votre mur.

LV: BRĪDINĀJUMS PAR APGĀŠANOS!

Šis produkts ir jāpiestiprina pie sienas ar komplektā iekļauto(-ajiem) kronšteinu(-iem), lai novērstu nāvējošu savainojumu risku, tam apgāžoties. Iepakojuma ir skrūves tikai pretapgāšanās kronšteina(-u) piestiprināšanai pie produkta. Informāciju par to, kādas skrūves piemērotas Jūsu sienai, jautājiet saimniecības preču vai būvizstrādājumu veikalā.

LT: ĮSPĖJIMAS DĖL NUVERTIMO!

Šį gaminį būtina tinkamai pritvirtinti prie sienos naudojant pridėtas gembes, kad išvengtumėte mirtino sužalojimo jam nuvirtus. Pakuotėje yra tik varžtai gembėms prie gaminio pritvirtinti. Užeiškite į artimiausią statybinių prekių parduotuvę ir paprašykite savo sienai tinkamiausių varžtų (kaiščių).

EE: ÜMBERKUKKUMISOHT!

Toote ümberkukkumisest tuleneda võiva eluohtliku õnnetuse vältimiseks tuleb see kinnitada komplekti kuuluva(te) kronsteini(de) abil püsivalt seina külge. Komplekti kuuluvad ainult kruvid, mis on mõeldud ümberkukkumist takistava(te) kronsteini(de) kinnitamiseks toote külge. Soovituste saamiseks sobivate kruvide/tüüblite leidmiseks oma seina jaoks, konsulteerige DIY esindaja või rauakaupade kaupluse müüjaga.

BY: ПРЕДУПРЕЖДЕНИЕ ОБ ОПРОКИДЫВАНИИ!

Во избежание опрокидывания это изделие должно быть надежно прикреплено к стене с помощью прилагаемых кронштейнов. В комплект входят винты только для прикрепления кронштейнов к самому изделию. Шурупы и дюбели для крепления к стене конкретного типа можно найти в строительном или хозяйственном магазине.



EN: GENERAL INSTRUCTION FOR FURNITURE WITH FABRIC!

Wipe clean with a damp cloth. Use only clean water.

Dust and dirt can be vacuum cleaned or wiped with a clean soft cloth.

Do not use detergents, solvents or other chemicals on fabric as this may cause discoloration.

However, certain removable fabrics may be washed, but in such cases there will ALWAYS be a washing instruction on the fabric.

FR: INSTRUCTIONS GÉNÉRALES POUR LE MOBILIER EN TISSU !

Nettoyez à l'aide d'un chiffon humide. N'utilisez que de l'eau claire.

La poussière et la saleté peuvent être aspirées ou essuyées à l'aide d'un chiffon doux et propre.

N'utilisez aucun détergent, solvant ou autre produit chimique sur le tissu, car ceci pourrait le décolorer.

Cependant, certains tissus amovibles peuvent être lavés, mais dans ce cas le tissu comportera TOUJOURS des instructions de lavage.

LV: VISPĀRĪGI KOPŠANAS NORĀDĪJUMI MĒBELĒM AR AUDUMU!

Noslaukiet ar mitru drānu. Izmantojiet tikai tīru ūdeni.

Putekļus un netīrumus var notīrīt ar putekļusūcēju vai noslaucīt ar mīkstu drānu.

Auduma tīrīšanai neizmantojiet mazgāšanas līdzekļus, šķīdinātājus vai citas ķīmikālijas, jo auduma krāsa var izbalēt.

Atsevišķus noņemamos audumus var mazgāt, taču tad uz auduma VIENMĒR būs sniegti kopšanas norādījumi.

LT: BENDROSIOS INSTRUKCIJOS BALDAMS PADENGTIEMS AUDINIUI

Švariai nušluostykite drėgna šluoste. Naudokite tik švarų vandenį.

Dulkės ir nešvarumai gali būti susiurbti arba nuvalyti švaria, minkšta šluoste.

Nenaudokite detergentų, tirpiklių ar kitų chemikalų audiniams, nes šie gali sukelti spalvos išblukimą.

Visgi, kai kurie nuimami audiniai gali būti skalbiami, bet tokiais atvejais ant audinio etiketės VISADA turi būti pateiktos skalbimo instrukcijos.

EE: ÜLDISED JUHISED KANGAGA MÖÖBLI JAOKS!

Puhastage niiske lapiga. Kasutage ainult puhast vett.

Tolmu ja mustust saab eemaldada tolmuimejaga või ära pühkida puhta pehme lapiga.

Ärge kasutage kangal pesuvahendeid, lahusteid või muid kemikaale, kuna see võib põhjustada värvimuutusi.

Küll aga võib teatud eemaldatavaid kangaid pesta, kuid sellisel juhul on kanga küljes ALATI pesujuhend.

BY: ОБЩИЕ УКАЗАНИЯ ПО УХОДУ ЗА МЕБЕЛЬЮ С ОТДЕЛКОЙ ИЗ ТКАНИ!

Очистите изделие чистой влажной тряпкой. Используйте только чистую воду.

Пыль и грязь можно удалять пылесосом или чистой мягкой тряпкой.

Не наносите моющие средства, растворители или другие химические вещества на ткань, поскольку они могут привести к вымыванию цвета.

Некоторые съемные элементы из ткани можно стирать. В таких случаях к ткани ОБЯЗАТЕЛЬНО прилагается инструкция по стирке.

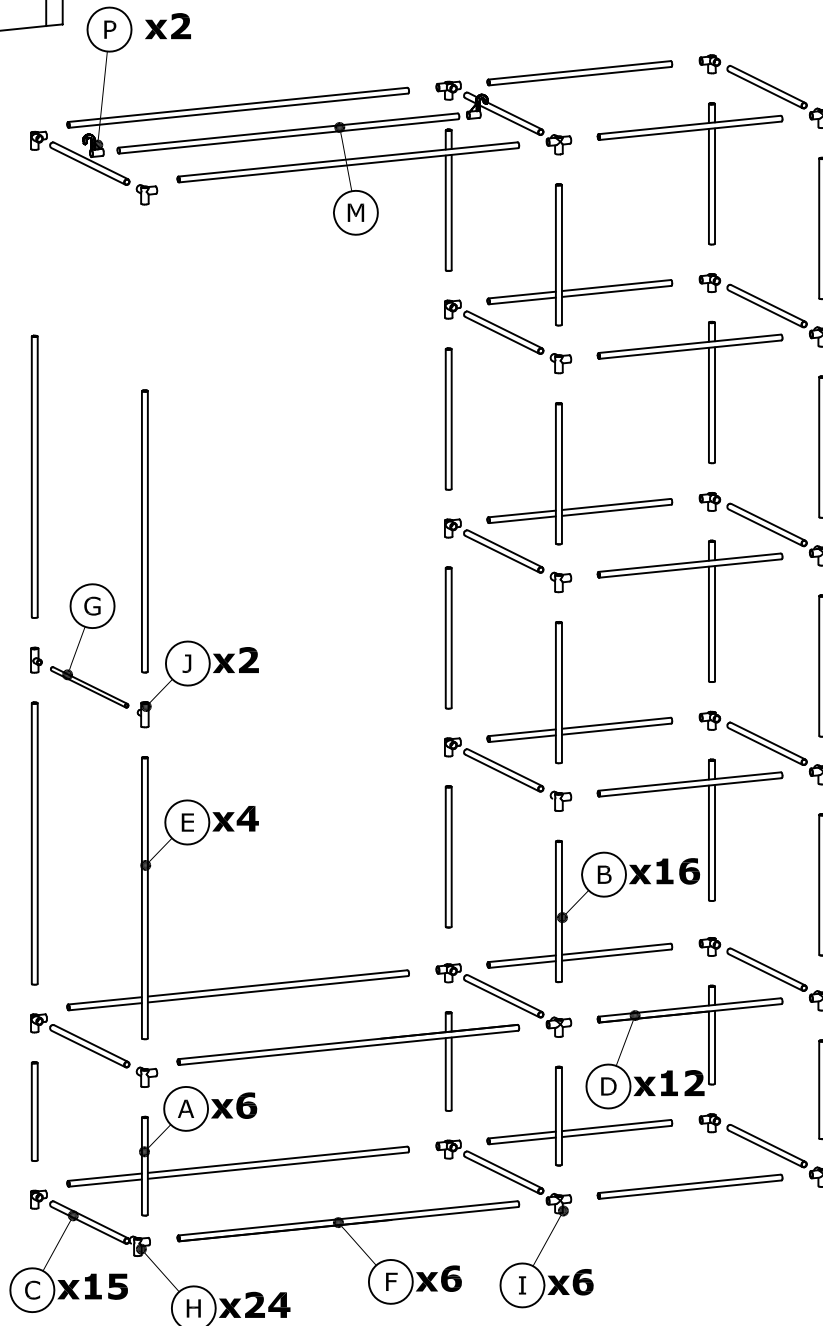
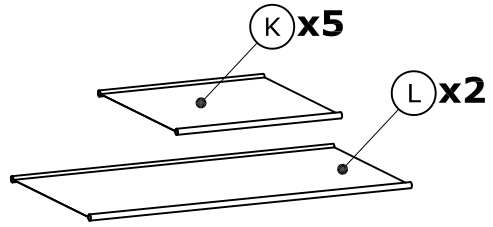
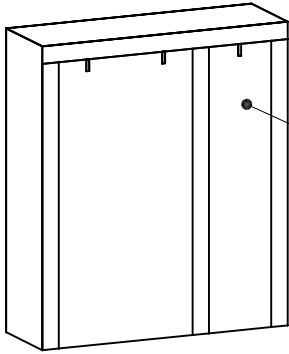

Box 1/1:

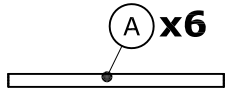

Ø15x250 mm

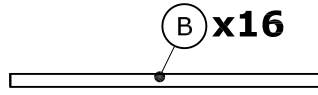

Ø15x359 mm

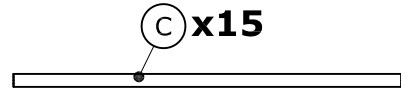

Ø15x450 mm

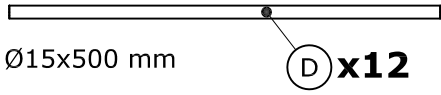

Ø15x500 mm

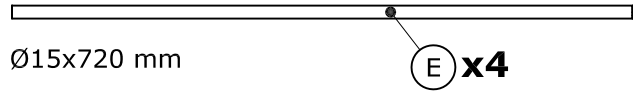

Ø15x720 mm

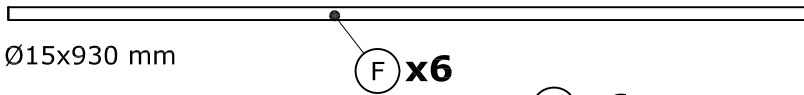

Ø15x930 mm



Ø10x450 mm

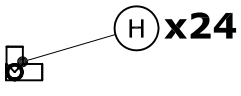

35x39x42 mm

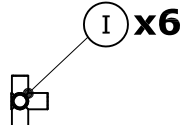

55x39x42mm

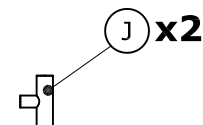

60x38x19 mm

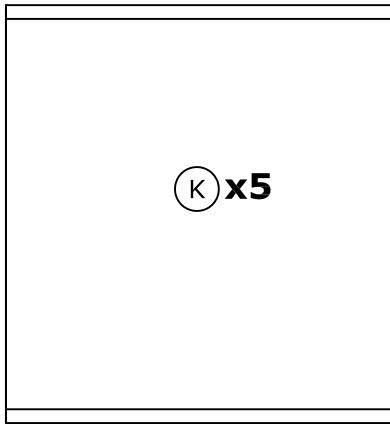

450x490 mm

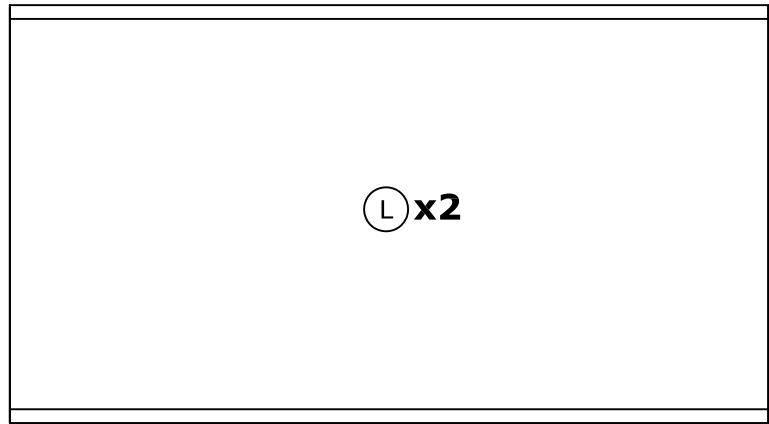

880x490 mm

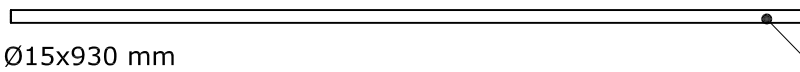

Ø15x930 mm

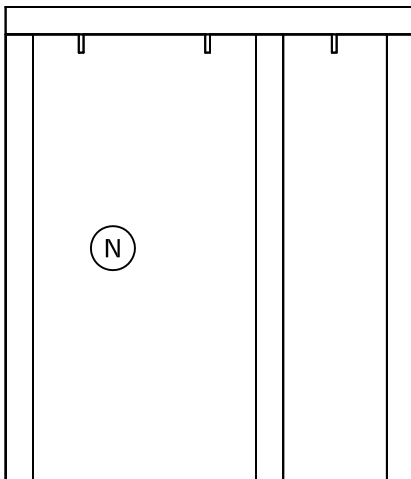

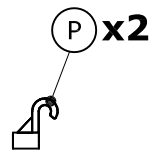

1490x500x1720 mm



59x53x18,5 mm

1

F x 4  Ø15x930 mm	L x 2  880x490 mm	
--	--	--

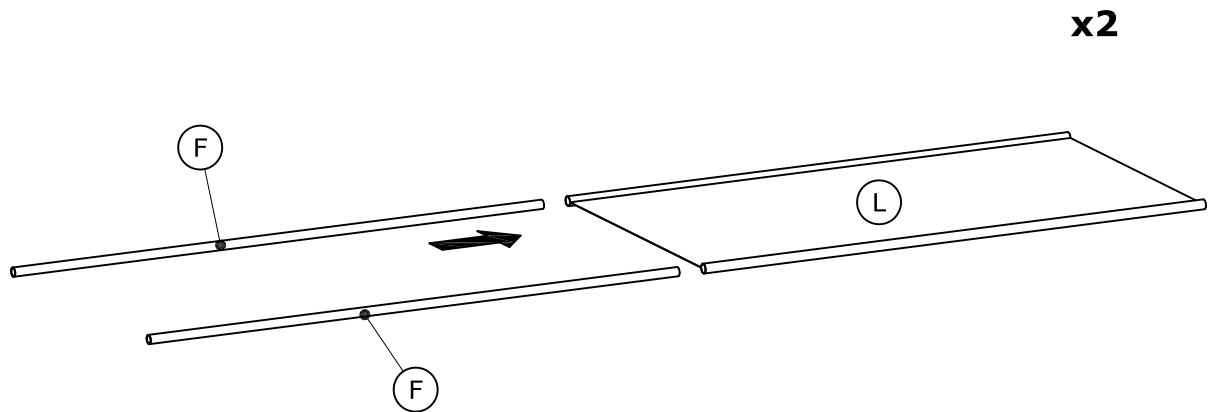

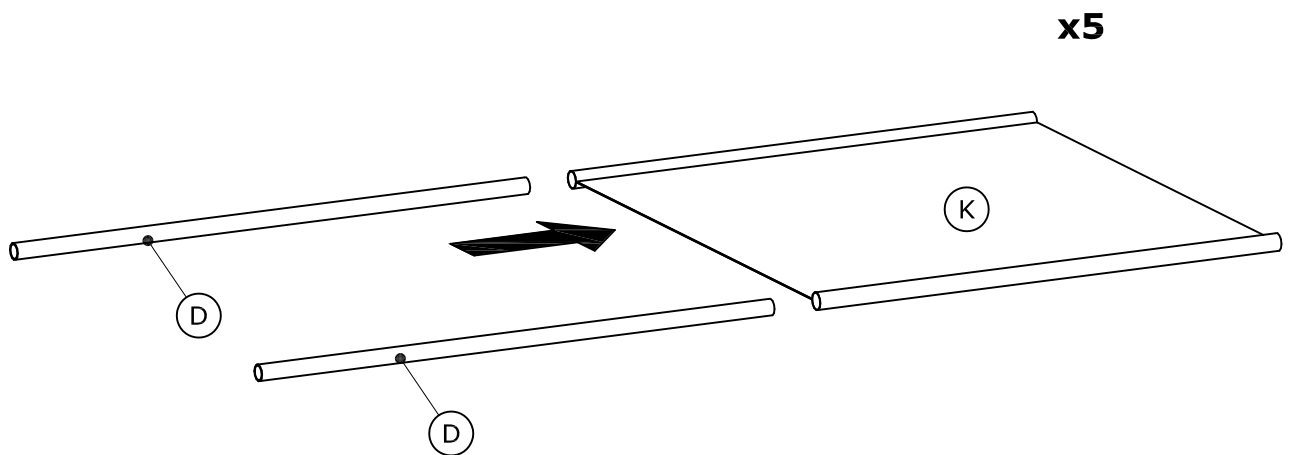

2

D x 10  Ø15x500 mm	K x 5  450x490 mm	
---	--	--



3

C x 6  Ø15x450 mm	H x 8  39x39x42 mm	I x 4  59x39x42 mm	
--	---	---	--

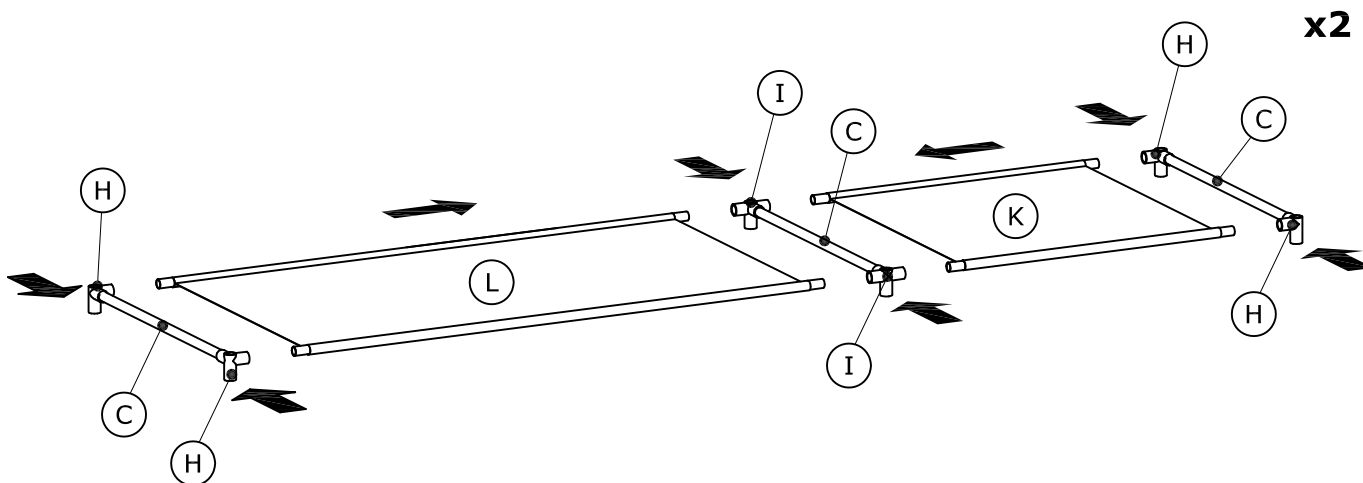
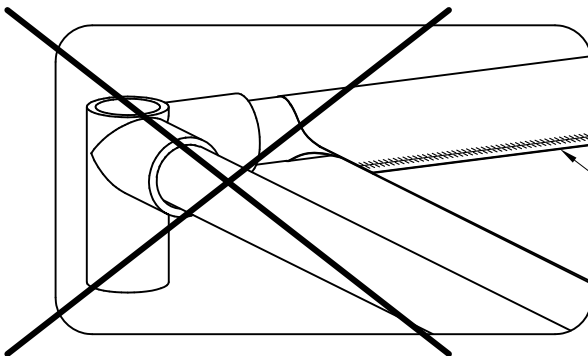
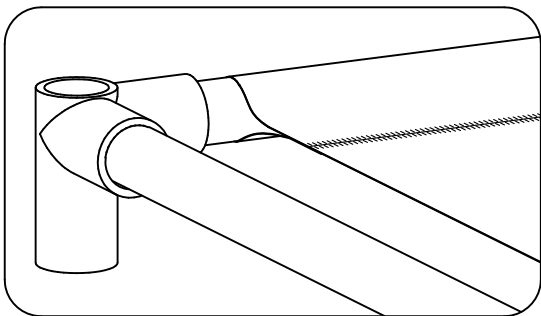

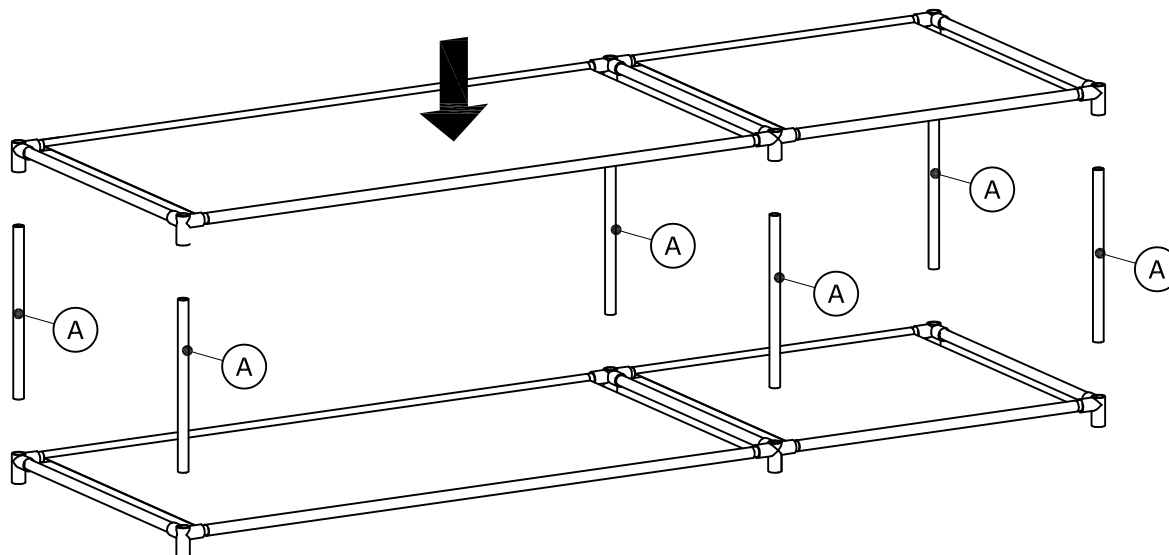

4

A x 6  Ø15x250 mm	
--	--



5

C x 6  Ø15x450 mm	H x 12  39x39x42 mm	
--	--	--

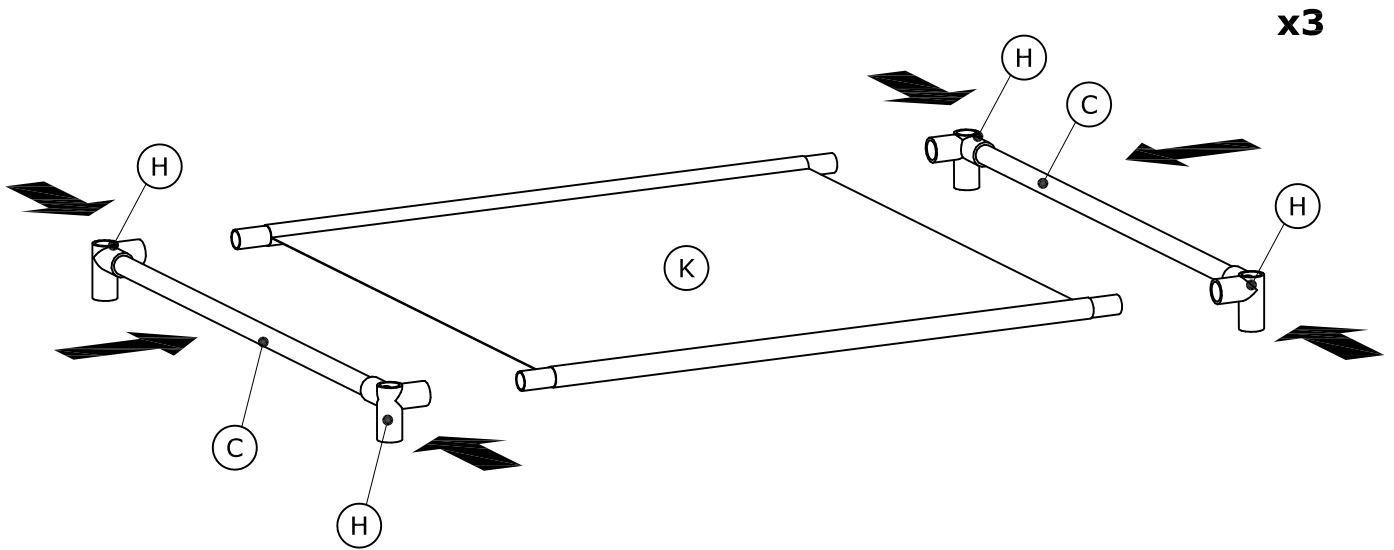

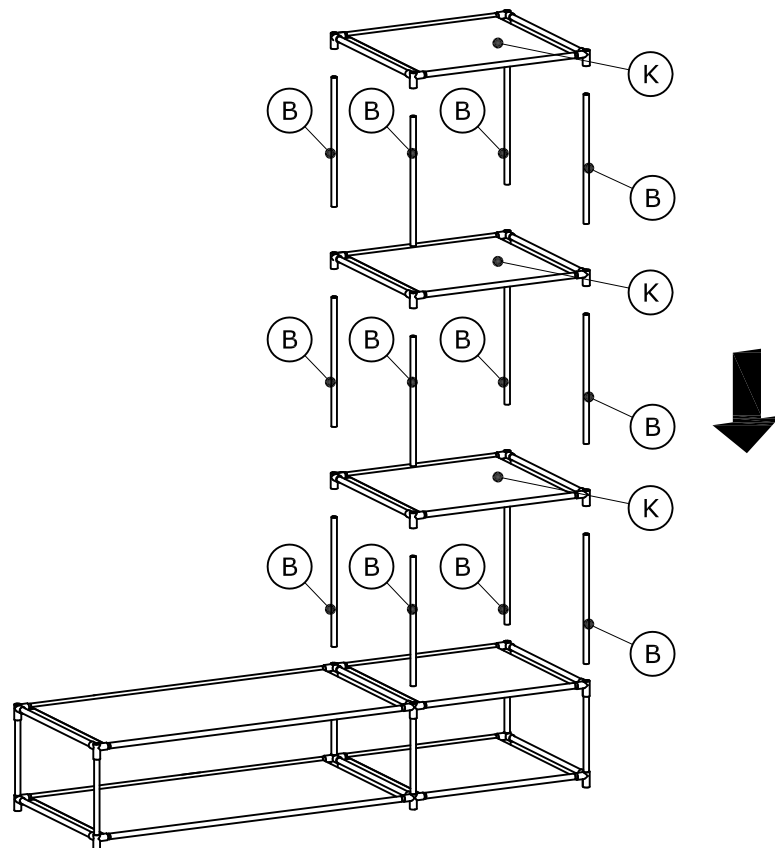

6

B x 12  Ø15x359 mm	
---	--





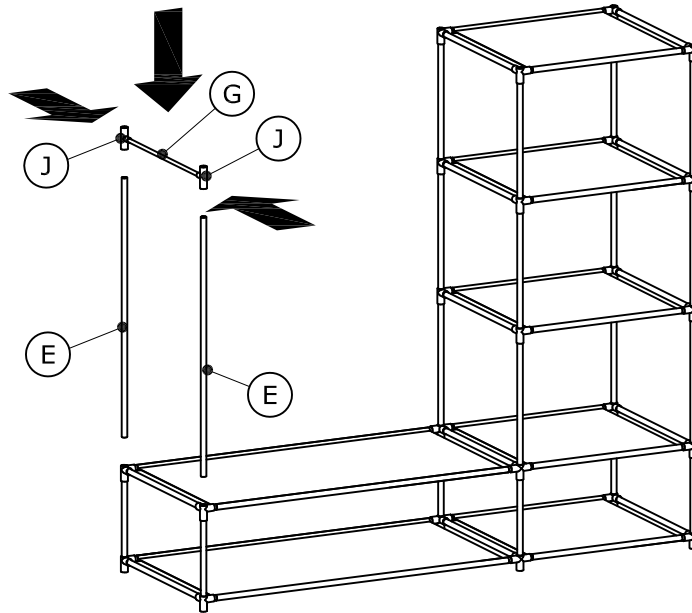

7

<p>E x 2</p>  <p>Ø15x720 mm</p>	<p>G x 1</p>  <p>Ø10x450 mm</p>	<p>J x 2</p>  <p>60x38x19 mm</p>	
--	--	---	--



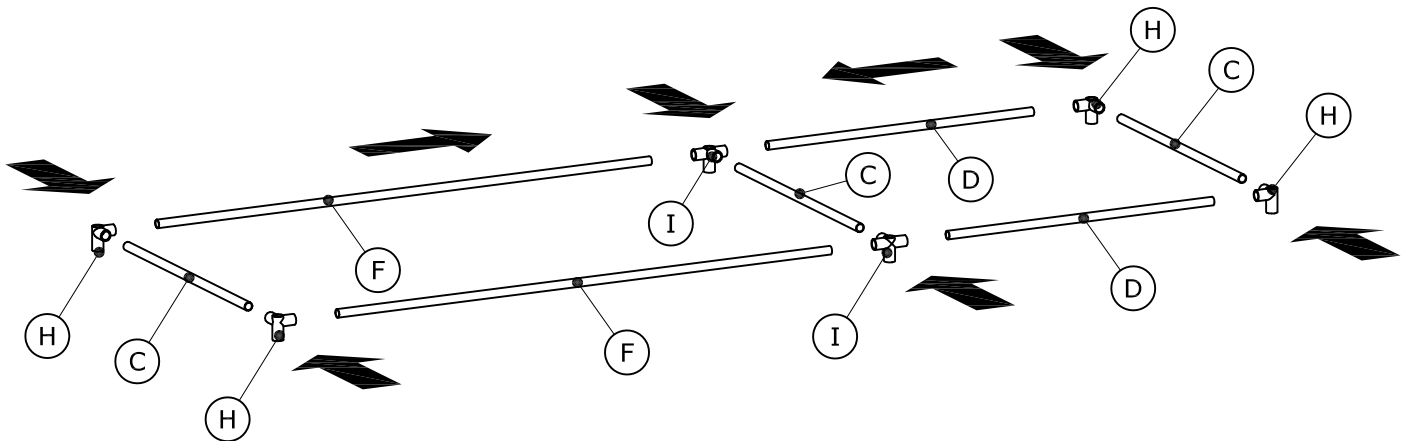

8

<p>C x 3</p>  <p>Ø15x450 mm</p>	<p>D x 2</p>  <p>Ø15x500 mm</p>	<p>F x 2</p>  <p>Ø15x930 mm</p>	<p>H x 4</p>  <p>39x39x42 mm</p>	<p>I x 2</p>  <p>59x39x42 mm</p>	
--	--	--	---	---	--



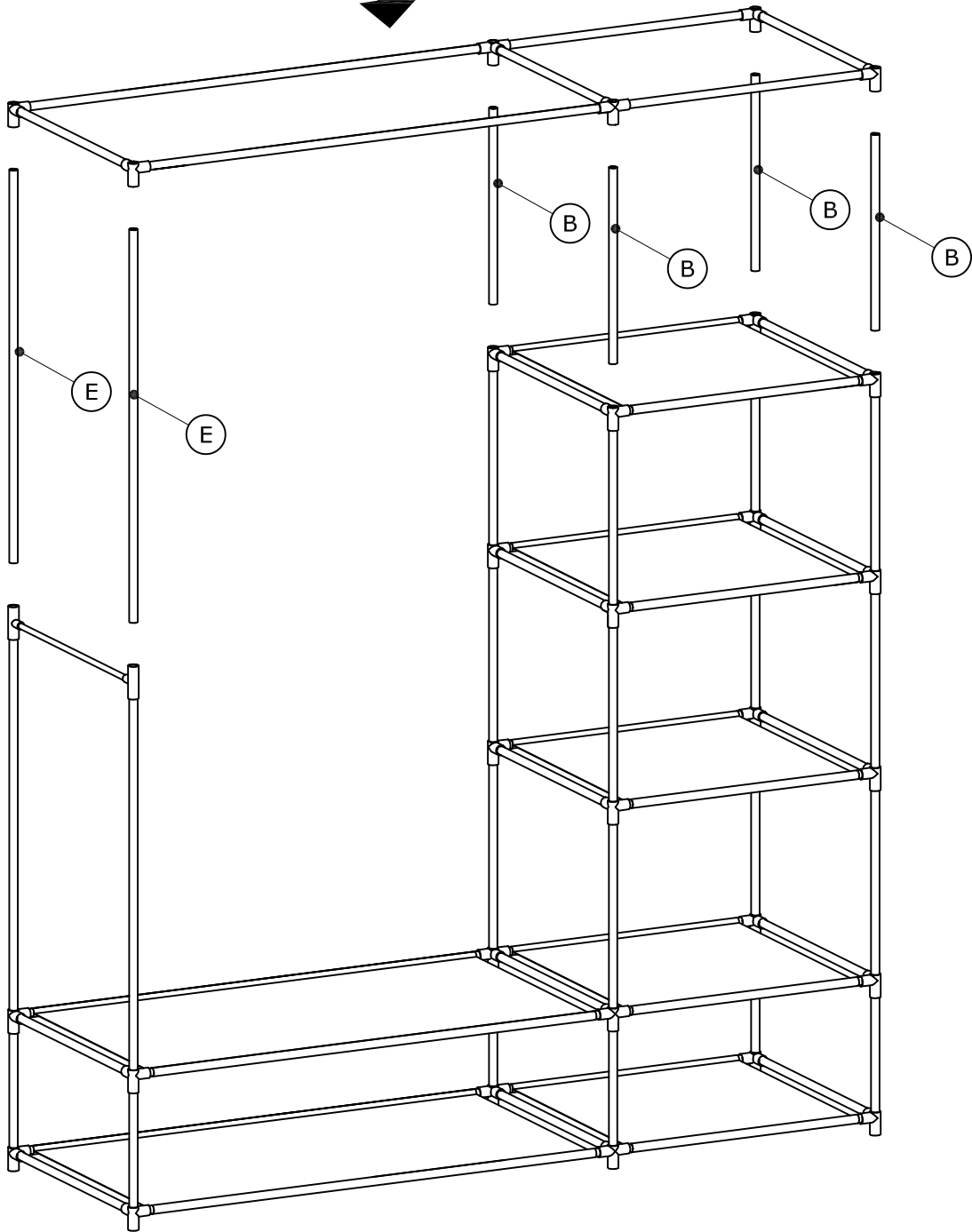

9

B x 4  Ø15x359 mm	E x 2  Ø15x720 mm	
--	--	--



10

M x 1  Ø15x930 mm	P x 2  59x53x18,5 mm	
--	---	--

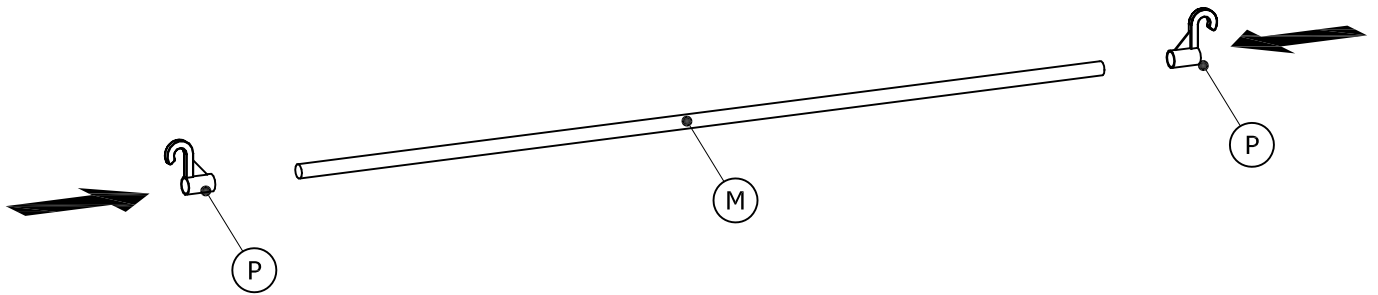

11

M x 1  Ø15x930 mm	
--	--

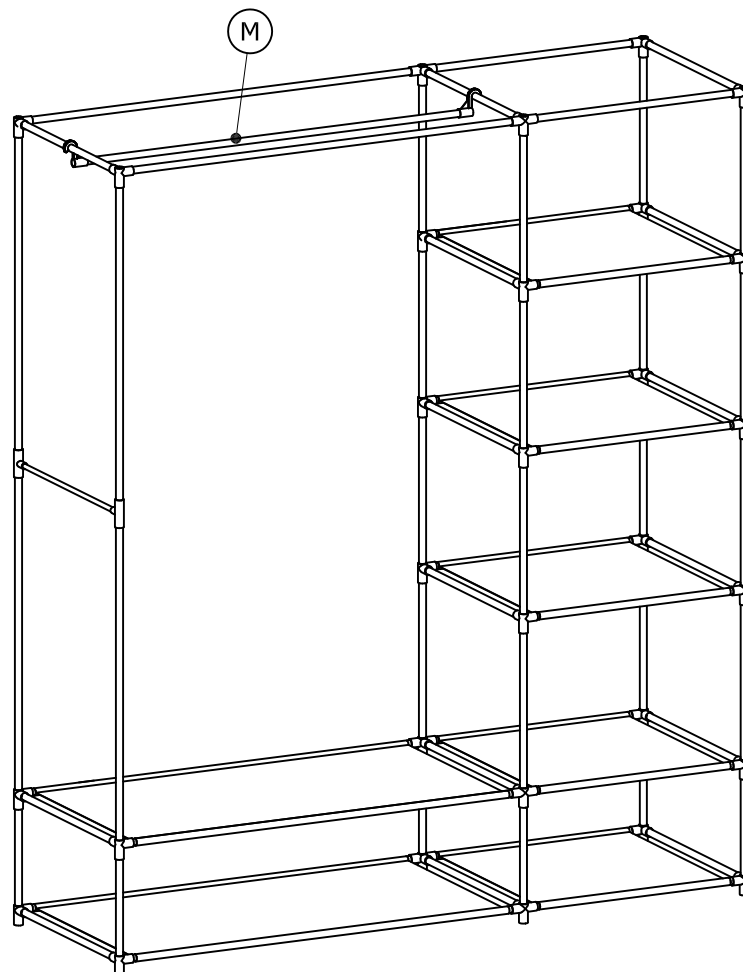

12

N x 1

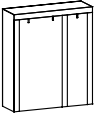

1490x500x1720 mm

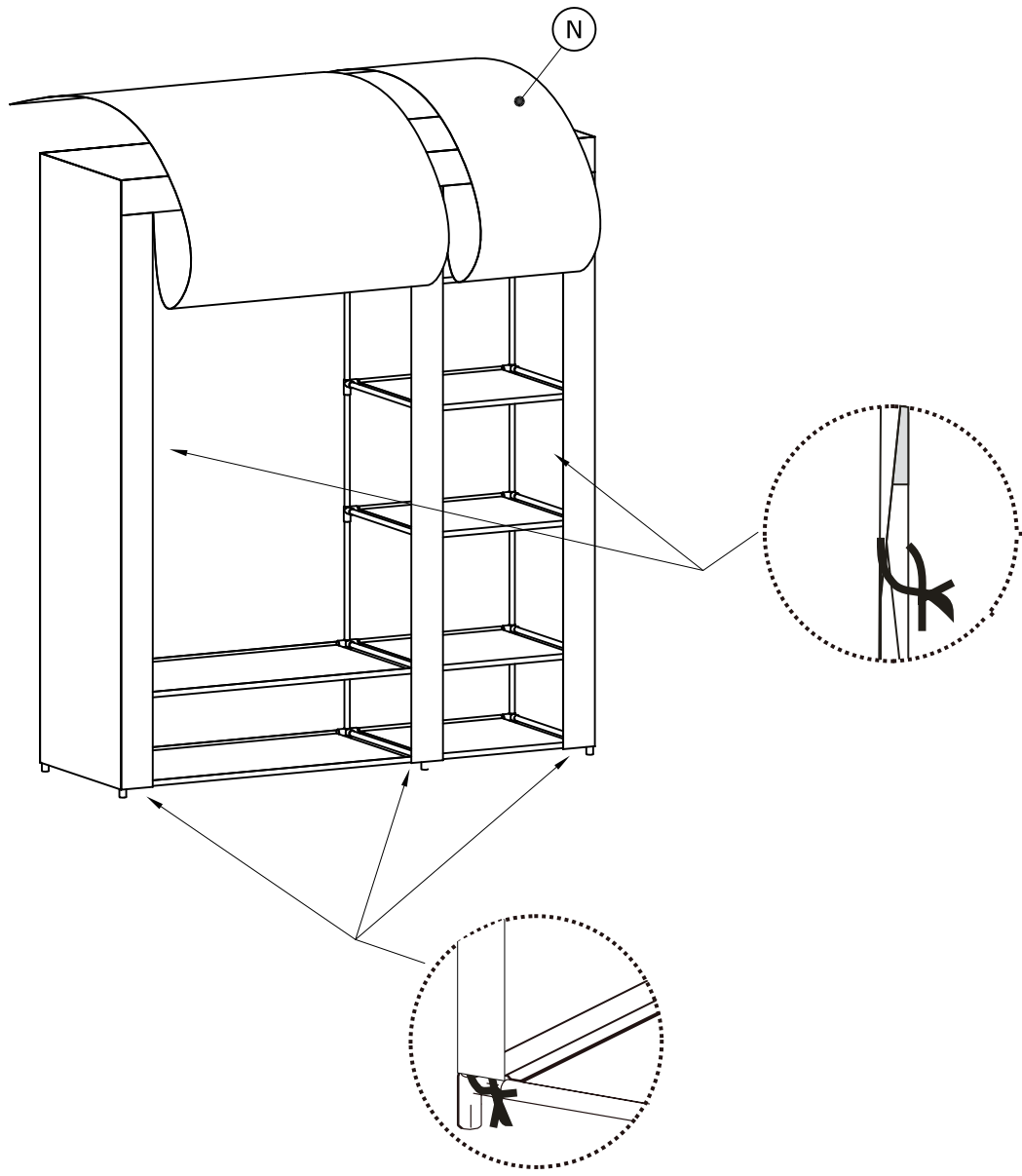

13

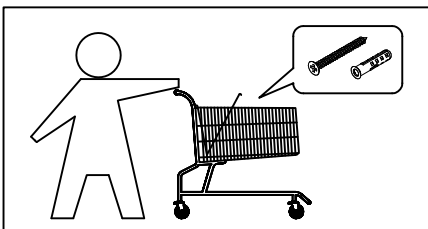
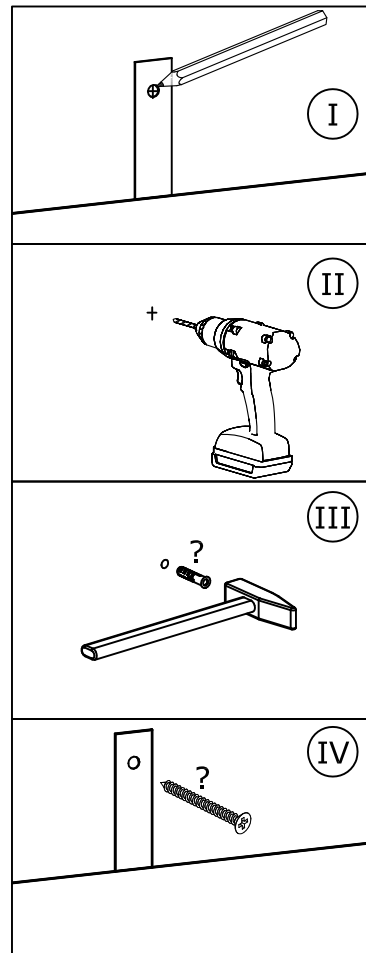
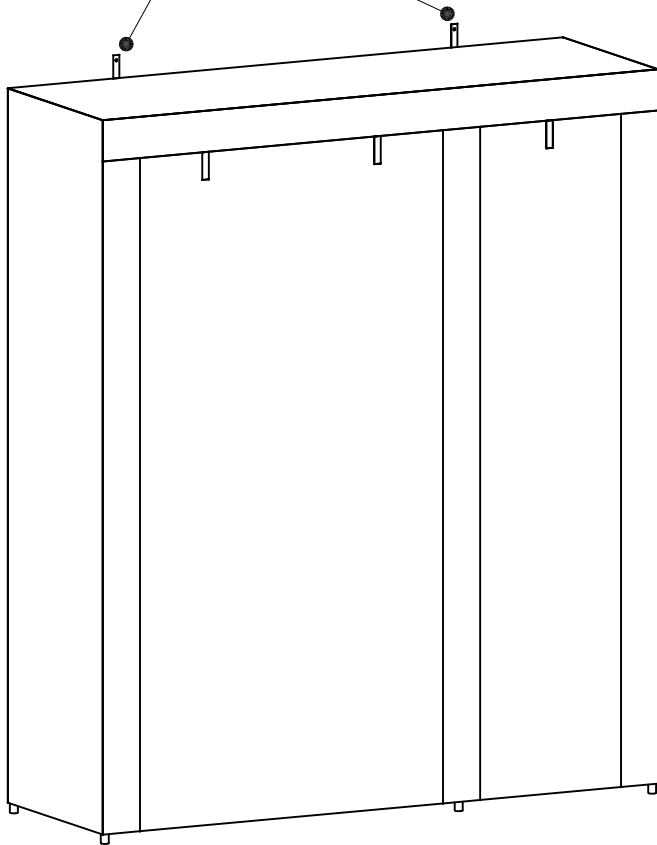
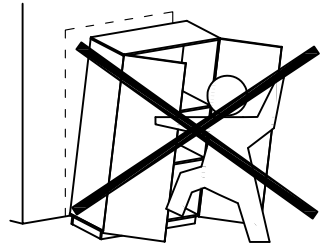
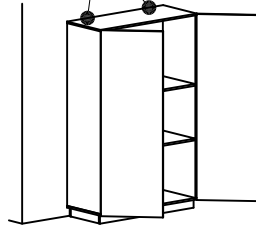

14

