

NORDSTRAND

910-196-1048

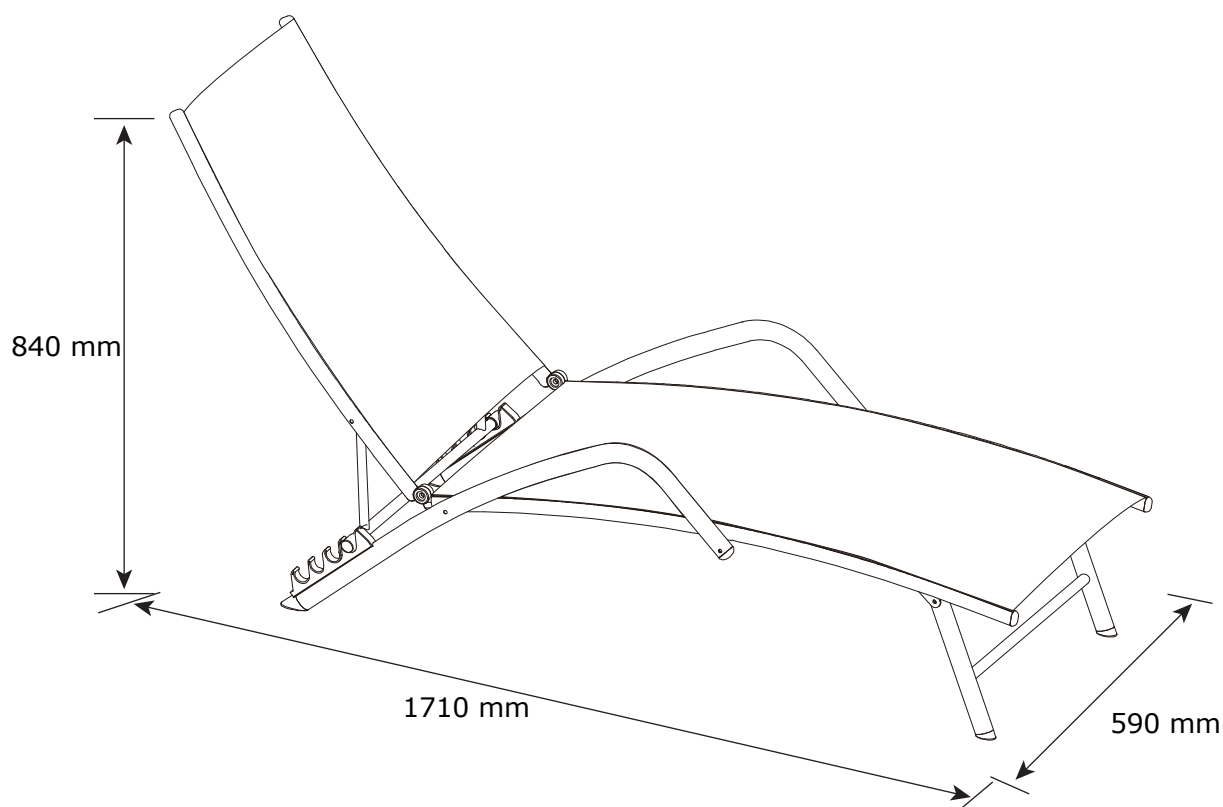

10.10.2020-Rev.1

1/13



JYSK.com



EN: IMPORTANT INFORMATION!

Please read the entire manual carefully before starting to assemble and/or using this product. Follow the manual thoroughly and keep it for further reference.

FR: INFORMATIONS IMPORTANTES

Veillez lire attentivement l'ensemble du manuel avant de commencer à monter et/ou utiliser ce produit. Suivez rigoureusement le manuel et conservez-le pour toute consultation ultérieure.

LV: SVARĪGA INFORMĀCIJA!

Pirms šī izstrādājuma montāžas un/vai lietošanas uzsākšanas pilnībā izlasiet lietošanas pamācību. Stingri ievērojiet pamācības norādījumus un saglabājiet to turpmākai lietošanai.

LT: SVARBI INFORMACIJA!

Prieš pradėdami montuoti gaminį ir (arba) juo naudotis, prašome atidžiai perskaityti visą vadovą. Atidžiai skaitykite vadovą ir turėkite jį su savimi, kad galėtumėte toliau vadovautis jo nuorodomis.

EE: OLULINE TEAVE!

Enne kui alustate toote kokku panemist ja/või kasutamist, lugege see kasutusjuhend hoolikalt läbi. Järgige täpselt juhendis toodud juhiseid ja hoidke juhend alles.

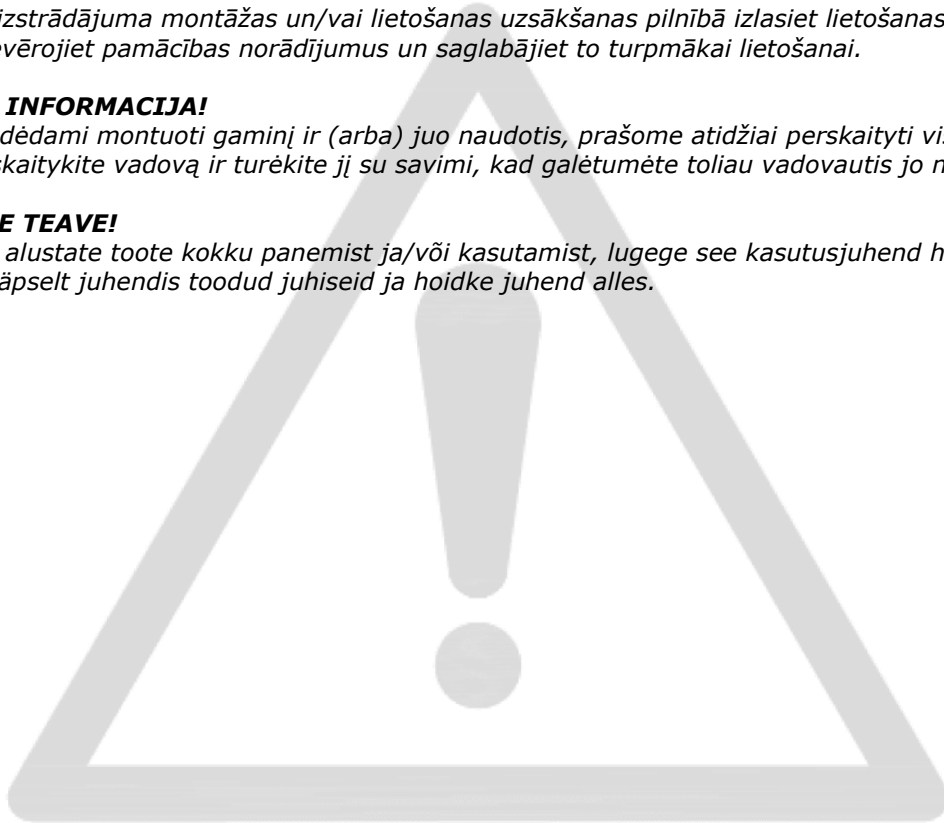

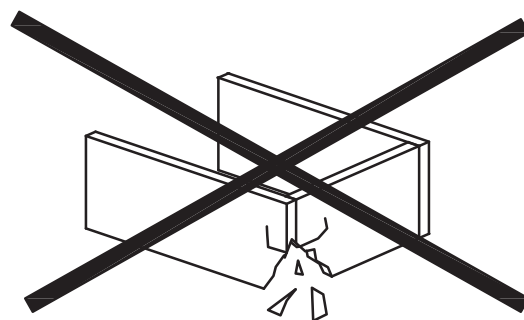
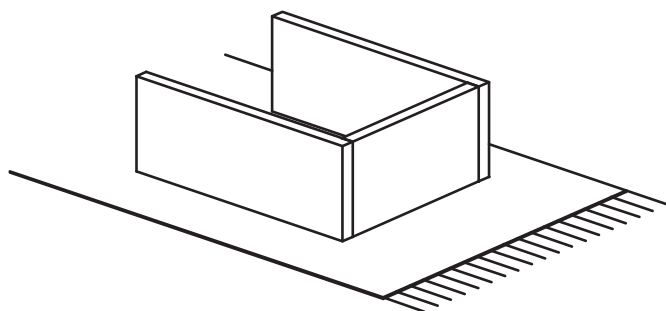

EN: WARNING TO AVOID SCRATCHES!

In order to avoid scratching this furniture should be assembled on a soft layer - could be a rug.

FR: AVERTISSEMENT POUR ÉVITER LES RAYURES

Afin d'éviter les rayures, ce meuble doit être monté sur une surface souple (un tapis, par exemple).

LV: BRĪDINĀJUMS PAR SKRĀPĒJUMIEM!

Lai nesaskrāpētu šo izstrādājumu, veiciet montāžu uz mīkstas pamatnes, piemēram, paklāja.

LT: ĮSPĖJIMAS, KAD IŠVENGTUMĖTE ĮBRĖŽIMŲ!

Šio baldo nesubraižysite, jei jį surinksite ant švelnaus paviršiaus, pavyzdžiui, kilimo.

EE: HOIATUS KRIIMUSTUSTE VÄLTIMISEKS!

Kriimustuste tekkimise vältimiseks mööblile tuleb see kokku panna pehmel pinnal, nt kaltsuvaibal.

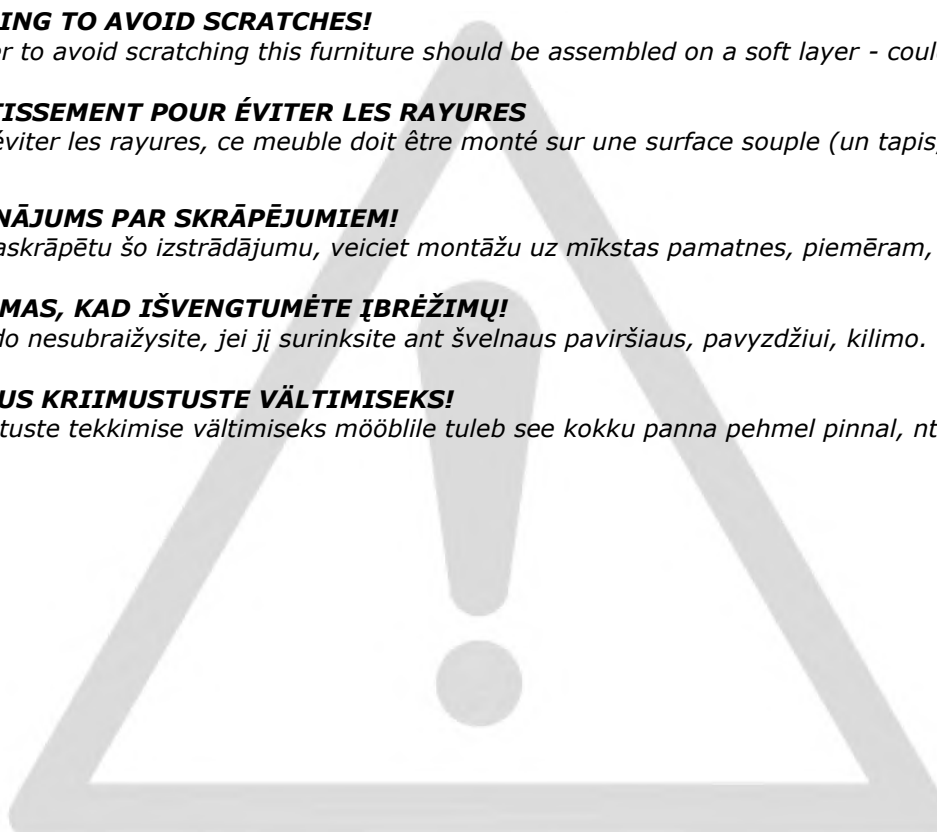

EN: IMPORTANT!

It is important that any product which is assembled using any kind of screw is re-tightened 2 weeks after assembly, and once every 3 months - in order to assure stability through-out the lifespan of the product.

FR: IMPORTANT

Il est important que tout produit monté à l'aide de vis soit resserré 2 semaines après son montage, puis tous les 3 mois, afin de garantir sa stabilité durant tout son cycle de vie.

LV: SVARĪGI!

Ir svarīgi, lai jebkuram produktam, kas tiek uzstādīts ar jebkādu skrūvju palīdzību, skrūves tiktu atkārtoti pievilktas 2 nedēļas pēc montāžas, pēc tam – reizi 3 mēnešos, tā nodrošinot stabilitāti visā izstrādājuma kalpošanas laikā.

LT: SVARBU!

Bet kokį varžtais tvirtinamą gaminį 2 savaites po surinkimo bei kas 3 mėnesius reikia papildomai suveržti – taip užtikrinamas naudojamo gaminio stabilumas.

EE: TÄHTIS!

Oluline on, et toote kruvisid pingutataks 2 nädalat pärast kokkupanekut ja seejärel iga 3 kuu järel, et tagada stabiilsus kogu toote eluea jooksul.





EN: GENERAL INSTRUCTION FOR FURNITURE WITH FABRIC!

Wipe clean with a damp cloth. Use only clean water.

Dust and dirt can be vacuum cleaned or wiped with a clean soft cloth.

Do not use detergents, solvents or other chemicals on fabric as this may cause discoloration.

However, certain removable fabrics may be washed, but in such cases there will ALWAYS be a washing instruction on the fabric.

FR: INSTRUCTIONS GÉNÉRALES POUR LE MOBILIER EN TISSU!

Nettoyez à l'aide d'un chiffon humide. N'utilisez que de l'eau claire.

La poussière et la saleté peuvent être aspirées ou essuyées à l'aide d'un chiffon doux et propre.

N'utilisez aucun détergent, solvant ou autre produit chimique sur le tissu, car ceci pourrait le décolorer.

Cependant, certains tissus amovibles peuvent être lavés, mais dans ce cas le tissu comportera TOUJOURS des instructions de lavage.

LV: VISPĀRĪGI KOPŠANAS NORĀDĪJUMI MĒBELĒM AR AUDUMU!

Noslaukiet ar mitru drānu. Izmantojiet tikai tīru ūdeni.

Putekļus un netīrumus var notīrīt ar putekļusūcēju vai noslaucīt ar mīkstu drānu.

Auduma tīrīšanai neizmantojiet mazgāšanas līdzekļus, šķīdinātājus vai citas ķīmikālijas, jo auduma krāsa var izbalēt.

Atsevišķus noņemamos audumus var mazgāt, taču tad uz auduma VIENMĒR būs sniegti kopšanas norādījumi.

LT: BENDROSIOS INSTRUKCIJOS BALDAMS PADENGTIEMS AUDINIUI!

Švariai nušluostykite drėgna šluoste. Naudokite tik švarų vandenį.

Dulkės ir nešvarumai gali būti susiurbti arba nuvalyti švaria, minkšta šluoste.

Nenaudokite detergentų, tirpiklių ar kitų chemikalų audiniams, nes šie gali sukelti spalvos išblukimą.

Visgi, kai kurie nuimami audiniai gali būti skalbiami, bet tokiais atvejais ant audinio etiketės VISADA turi būti pateiktos skalbimo instrukcijos.

EE: ÜLDISED JUHISED KANGAGA MÖÖBLI JAOKS!

Puhastage niiske lapiga. Kasutage ainult puhast vett.

Tolmu ja mustust saab eemaldada tolmuimejaga või ära pühkida puhta pehme lapiga.

Ärge kasutage kangal pesuvahendeid, lahusteid või muid kemikaale, kuna see võib põhjustada värvimuutusi.

Küll aga võib teatud eemaldatavaid kangaid pesta, kuid sellisel juhul on kanga küljes ALATI pesujuhend.

EN: WARNING FOR SEATING FURNITURE!

This seating furniture is tested for domestic use. Tested for 110 kg.

FR: AVERTISSEMENT POUR LE MOBILIER D'ASSISE!

Ce mobilier d'assise a été testé pour un usage domestique. Testé pour un poids de 110 kilos.

LV: BRĪDINĀJUMS SĒDMĒBELĒM!

Šī sēdmēbele ir pārbaudīta izmantošanai mājas apstākļos. Testēts uz: 110 kg.

LT: PERSPĖJIMAS DĖL BALDŲ, ANT KURIŲ SĖDIMA!

Šis baldas, skirtas sėdėti, išbandytas namų aplinkoje. Išbandyta esant 110 kg apkrovai.

EE: HOIATUS TOOLI KASUTAMISE KOHTA!

Tooli on testitud koduseks kasutamiseks. Testitud 110 kg kaalu puhul.



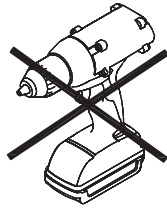

A x 2

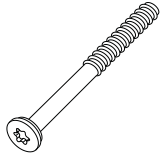

M6x52 mm

B x 2



M6x37 mm

C x 2



M6x30 mm

D x 6



M6x20 mm

E x 4



Ø6/Ø13 mm

F x 16



Ø6/Ø14 mm

G x 4



M6/10 mm

H x 12



Ø12 mm

J x 1



10 mm

K x 1

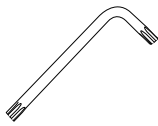

T25



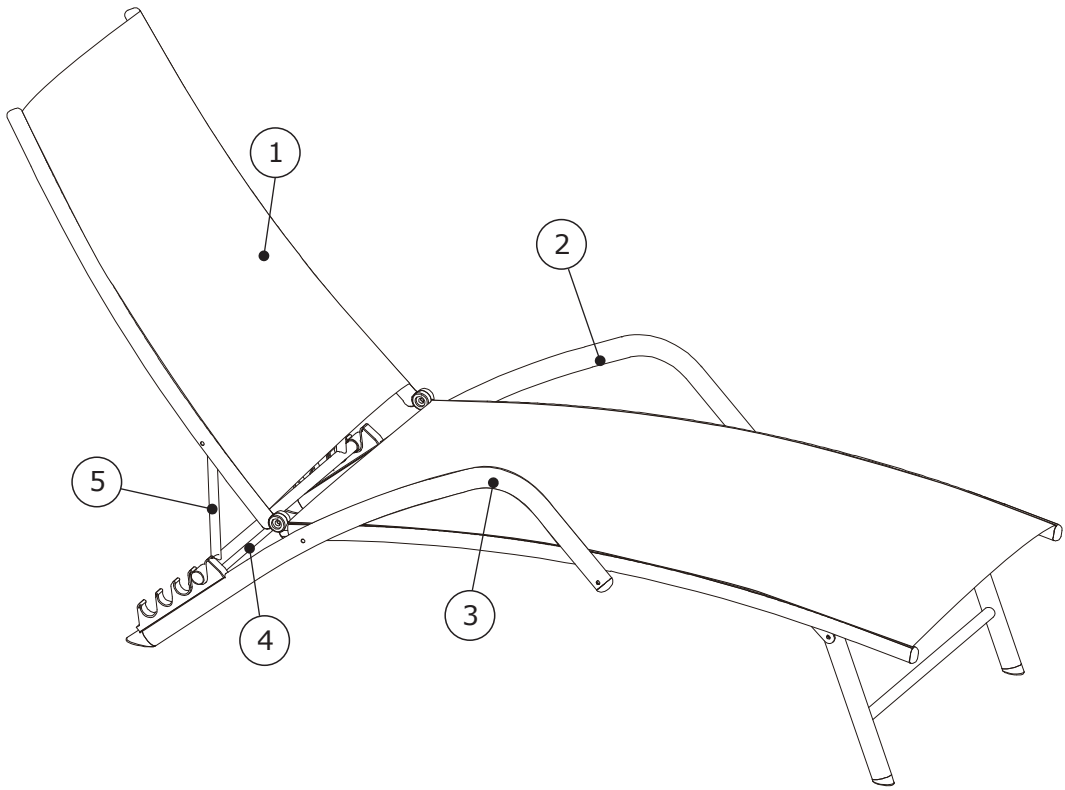

Box 1/1

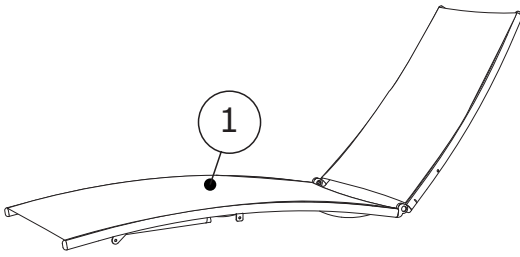

1167x540 mm

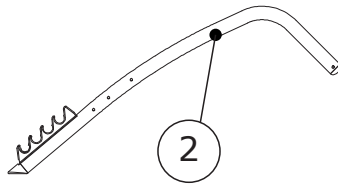

925x250 mm

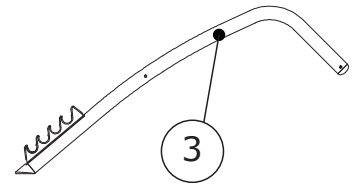

925x250 mm

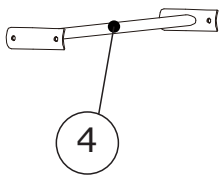

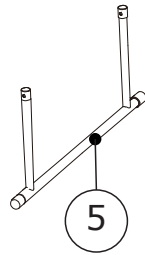

545x92 mm

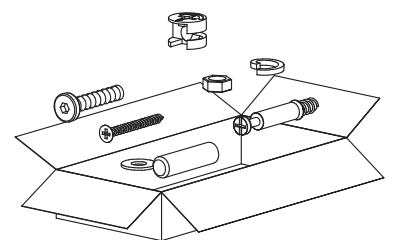

595x250 mm







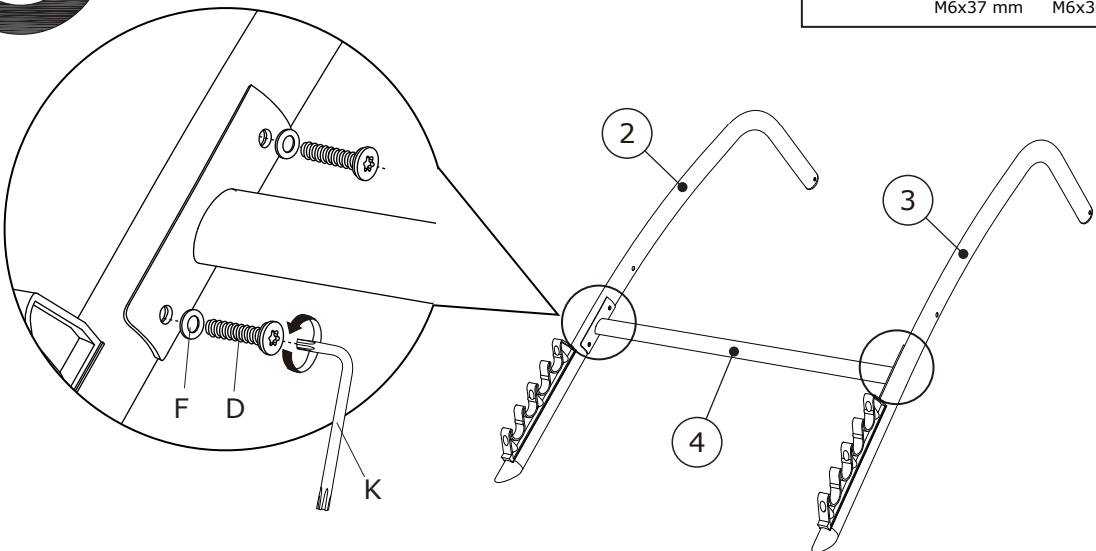
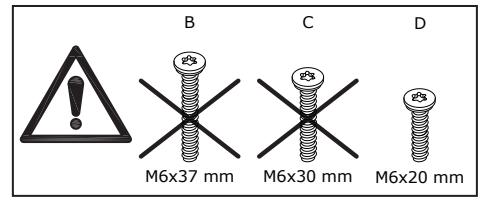
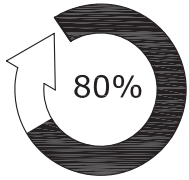

1

| | | | |
|--|---|---|--|
| D x 4  M6x20 mm | F x 4  Ø6/Ø14 mm | K x 1  T25 | |
|--|---|---|--|







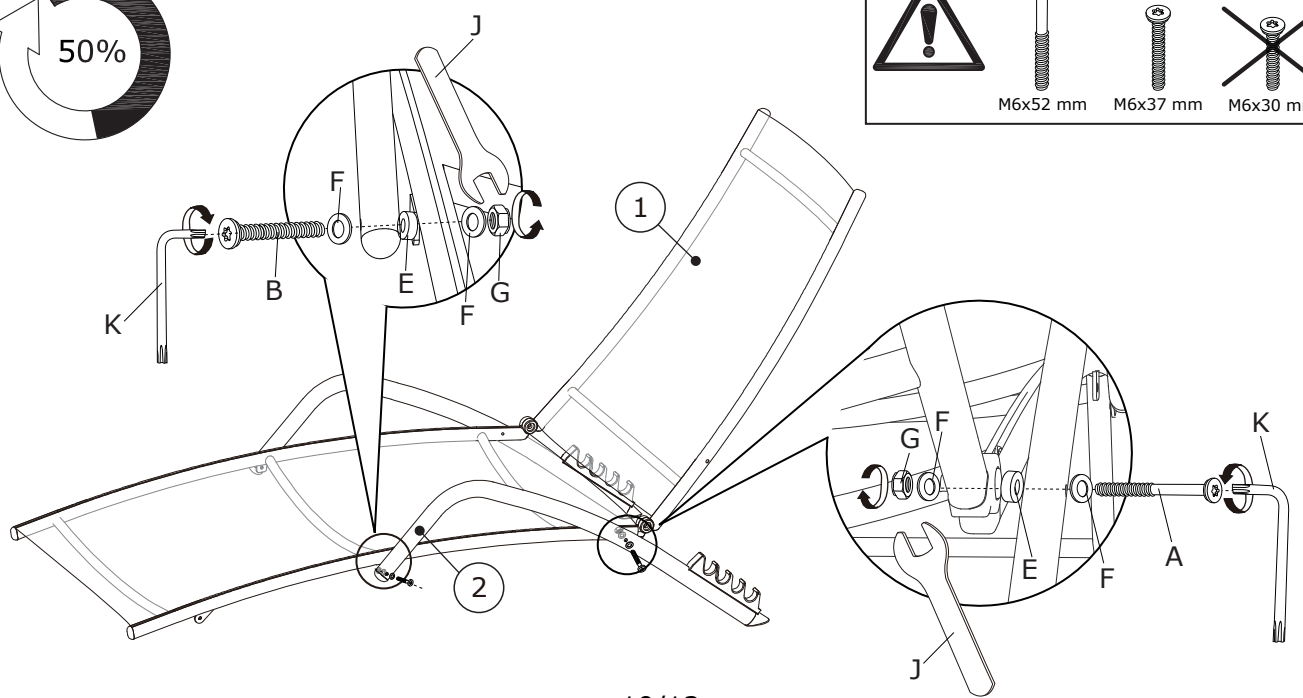
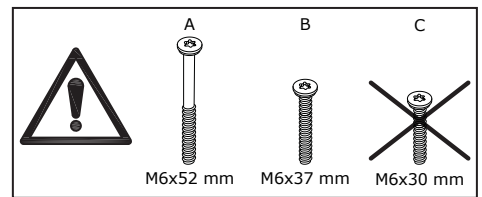
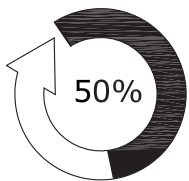

2

| | | | | | | |
|--|--|---|---|--|---|---|
| A x 1  M6x52 mm | B x 1  M6x37 mm | E x 2  Ø6/Ø13 mm | F x 4  Ø6/Ø14 mm | G x 2  M6/10 mm | J x 1  10 mm | K x 1  T25 |
|--|--|---|---|--|---|---|



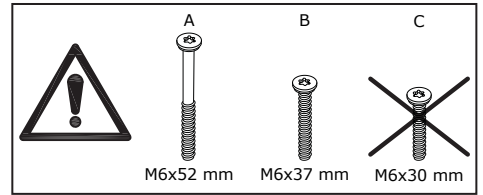
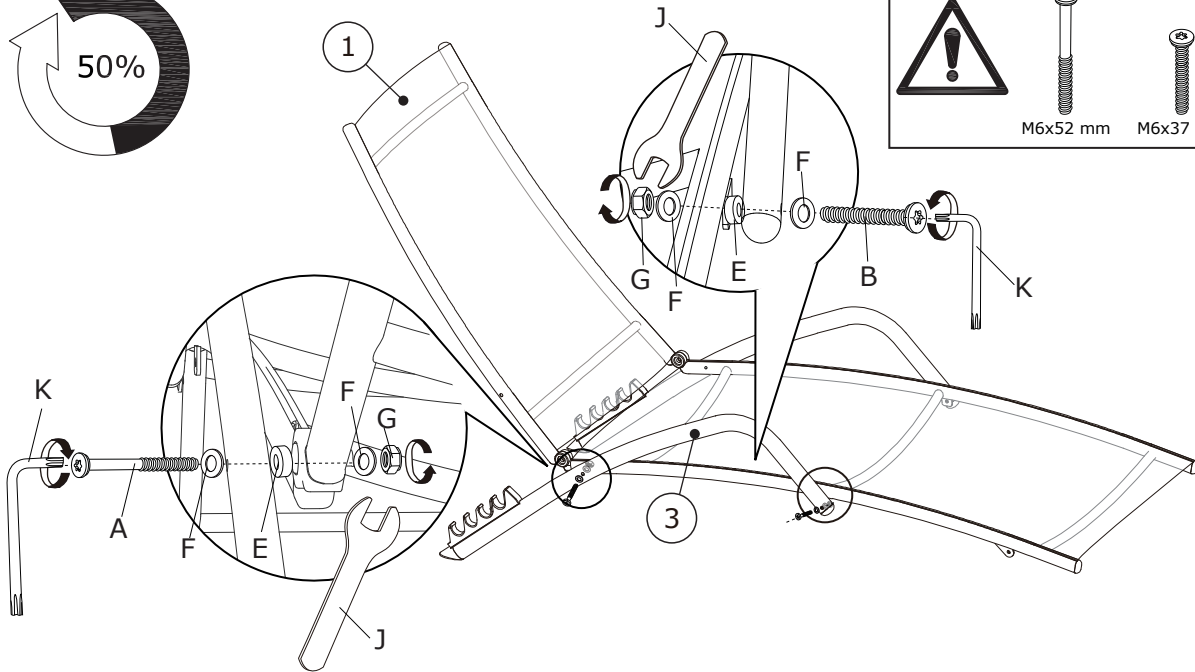
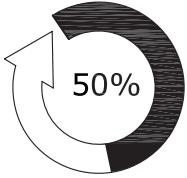

3

| | | | | | | |
|--|--|---|---|--|---|---|
| A x 1  M6x52 mm | B x 1  M6x37 mm | E x 2  Ø6/Ø13 mm | F x 4  Ø6/Ø14 mm | G x 2  M6/10 mm | J x 1  10 mm | K x 1  T25 |
|--|--|---|---|--|---|---|



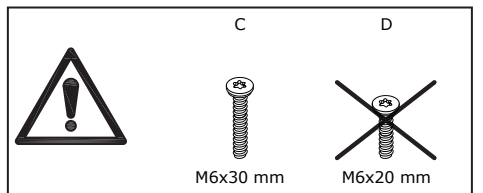
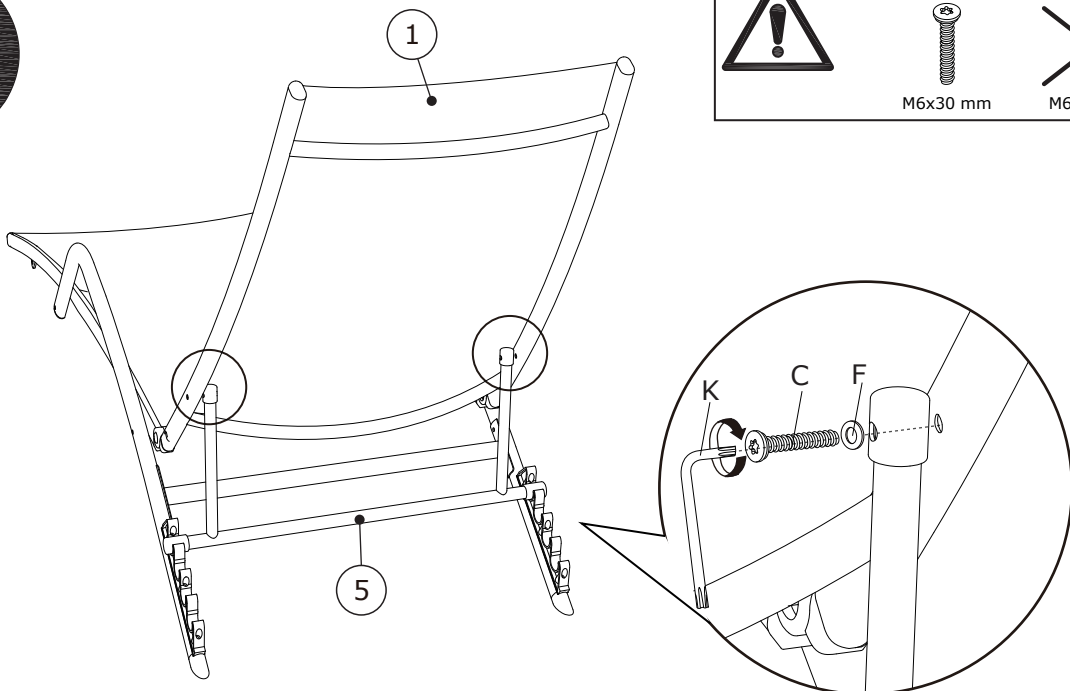
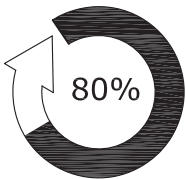

4

| | | | |
|--|---|---|--|
| C x 2  M6x30 mm | F x 2  Ø6/Ø14 mm | K x 1  T25 | |
|--|---|---|--|



5

| | | | |
|--|---|---|--|
| D x 2  M6x20 mm | F x 2  Ø6/Ø14 mm | K x 1  T25 | |
|--|---|---|--|

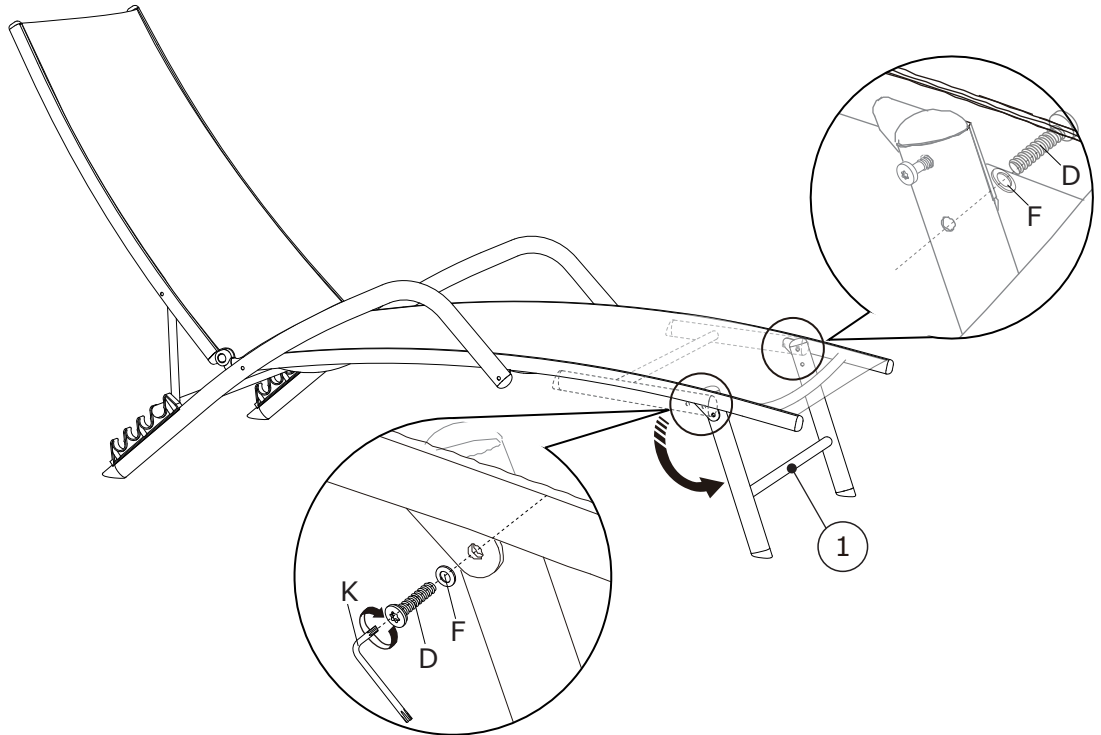
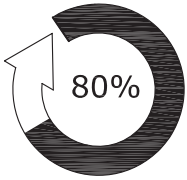

6

| | |
|---|--|
| K x 1  T25 | |
|---|--|

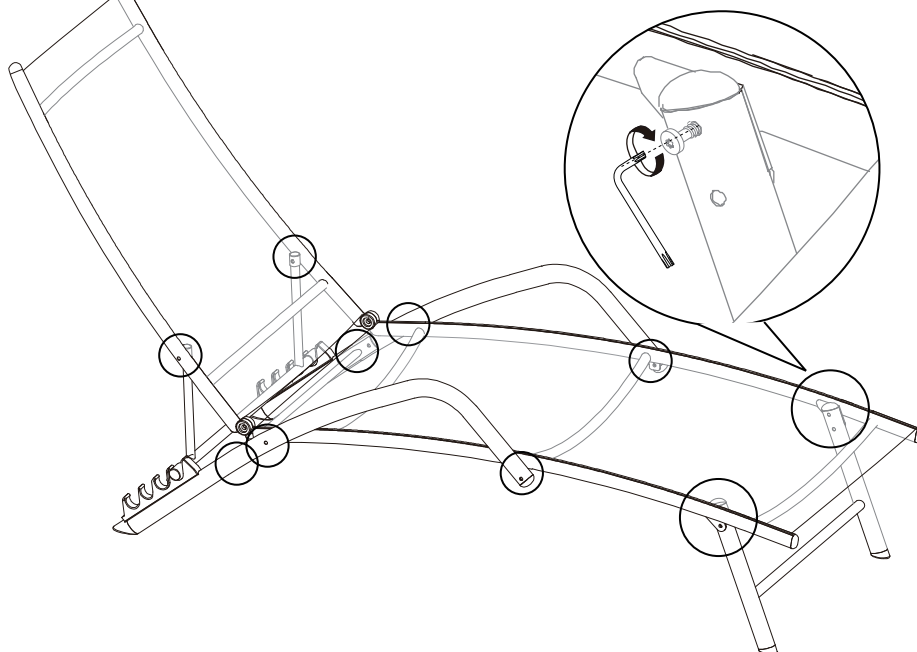
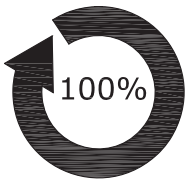

7

H x 12



Ø12 mm

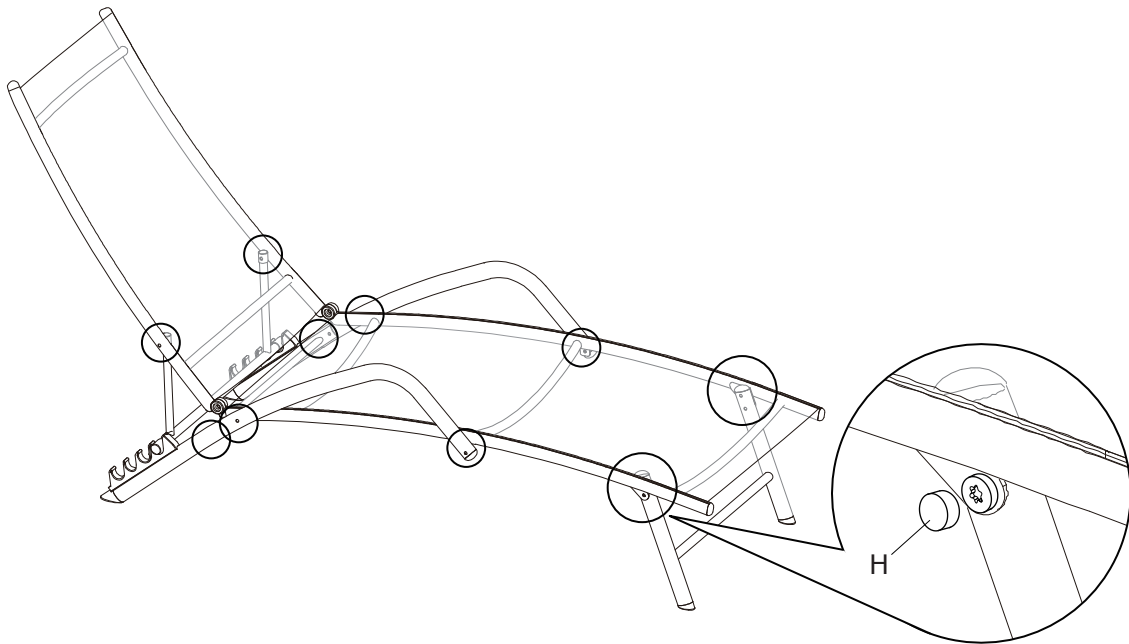

8

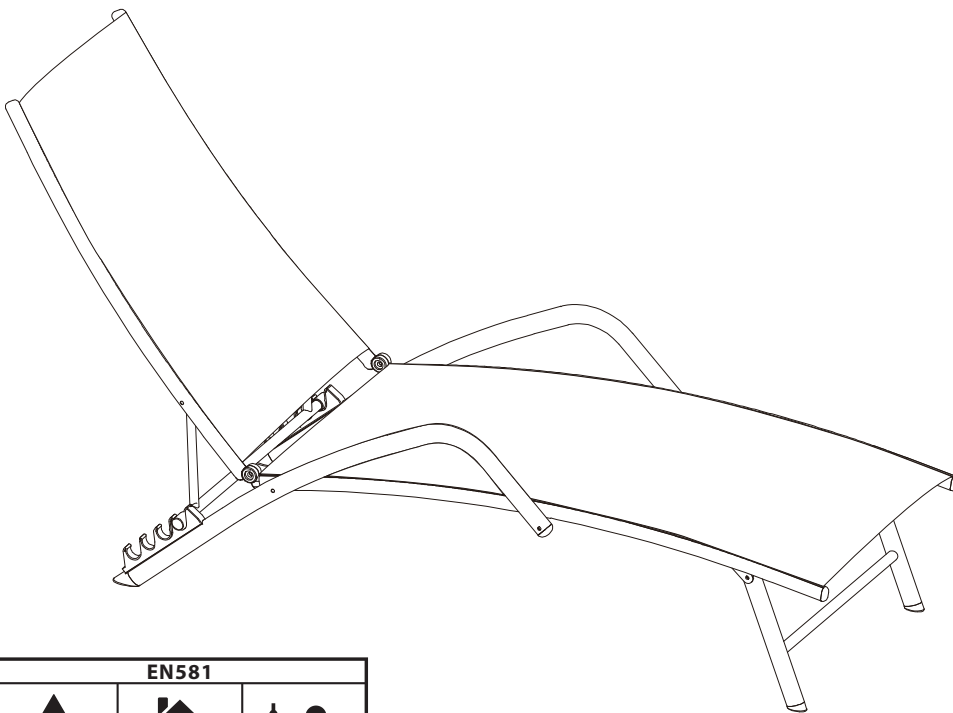

| EN581 | | |
|-------|---|---|
| | | |
| ✓ | ✓ | ✗ |